

# 1 $\mu$ H Line Impedance Stabilisation Network

## 1 Introduction

The TBL0110-2 LISN is a two path 50  $\Omega$  // 1  $\mu$ H LISN characterized from 30Hz – 500 MHz. It is based on the standard ECSS-E-ST-20-07C Rev 1. The standard provides the general schematic of the LISN and allows for some flexibility in component values. The TBL0110-2 implementation aims for use in EMC measurements of small satellites and spacecraft. The LISN does not have an output for conducted emission measurements; instead, it merely functions as a network for line impedance stabilisation. An RF current monitoring probe is used to measure conducted emissions, according to the standard.

The 1 $\mu$ H inductor mimics the typical inductance of the supply wire harness in small spacecraft or satellites. The LISN is inserted into the power line and power return line of the EUT.



## 2 Parameters

LISN type: V-AMN, 50  $\Omega$  // 1  $\mu$ H

Characterized frequency range: 30 Hz – 500 MHz

DC Resistance: 120 m $\Omega$

Maximum current: 10 A continuous

Operating voltage range: 0 – 60V DC

EUT / SOURCE terminals: 4 mm banana sockets

Dimensions: W 120 mm x L 175 mm x H 85 mm;

Weight: 0.9 kg

# 1 $\mu$ H Line Impedance Stabilisation Network

## 3 Impedance

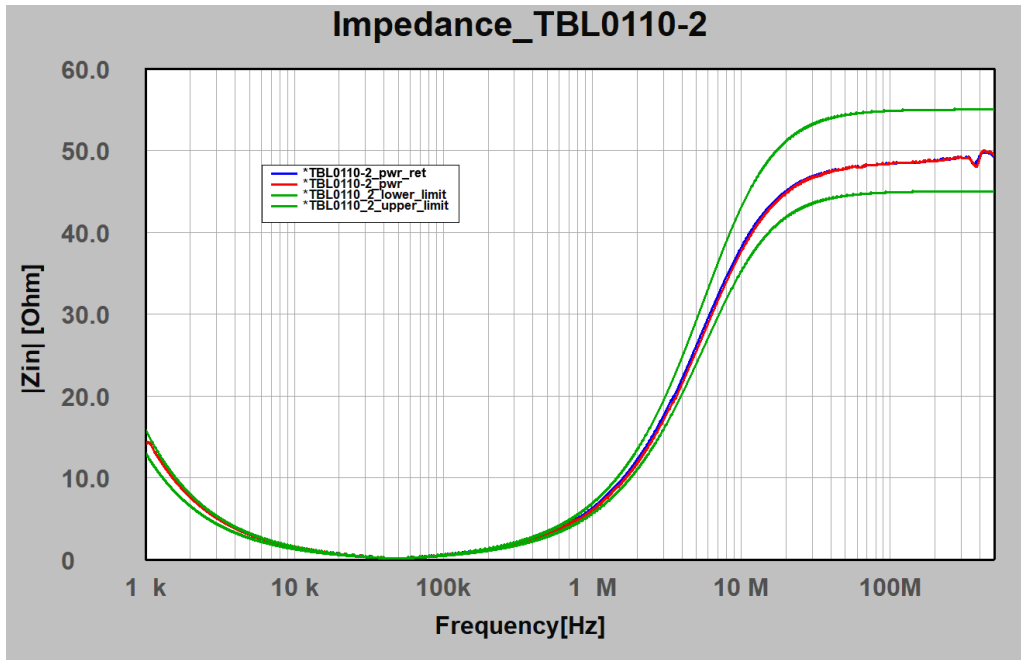

Impedance: 1 kHz – 500 MHz; source terminals open, typical data

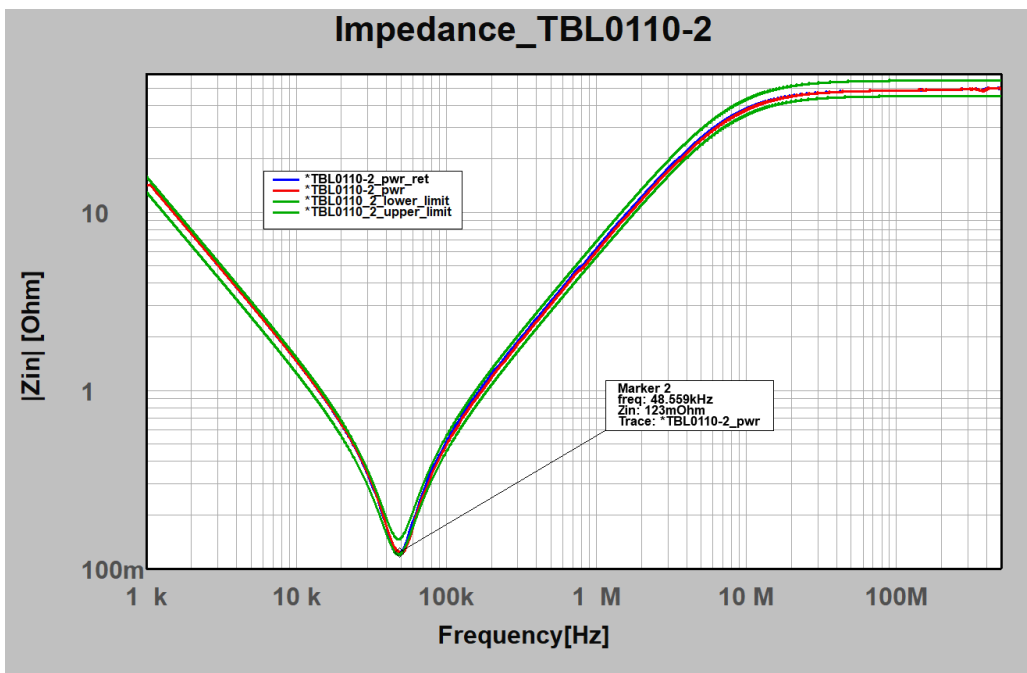

Impedance: 1 kHz – 500 MHz; logarithmic impedance axis, source terminals open, typical data

The standard does not specify impedance limits. The green traces represent a  $\pm 10\%$  tolerance band of the simulated impedance (ideal components/no parasitics);

# 1 $\mu$ H Line Impedance Stabilisation Network

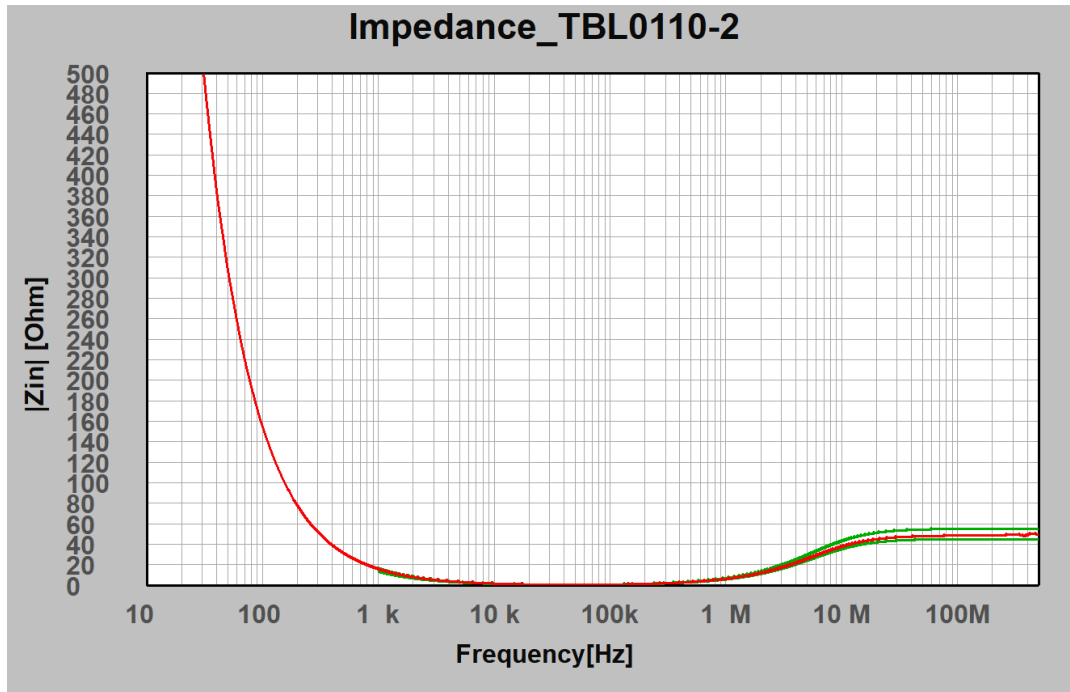

Impedance: 30 Hz – 500 MHz; logarithmic impedance axis, source terminals open, typical data

## 4 Phase

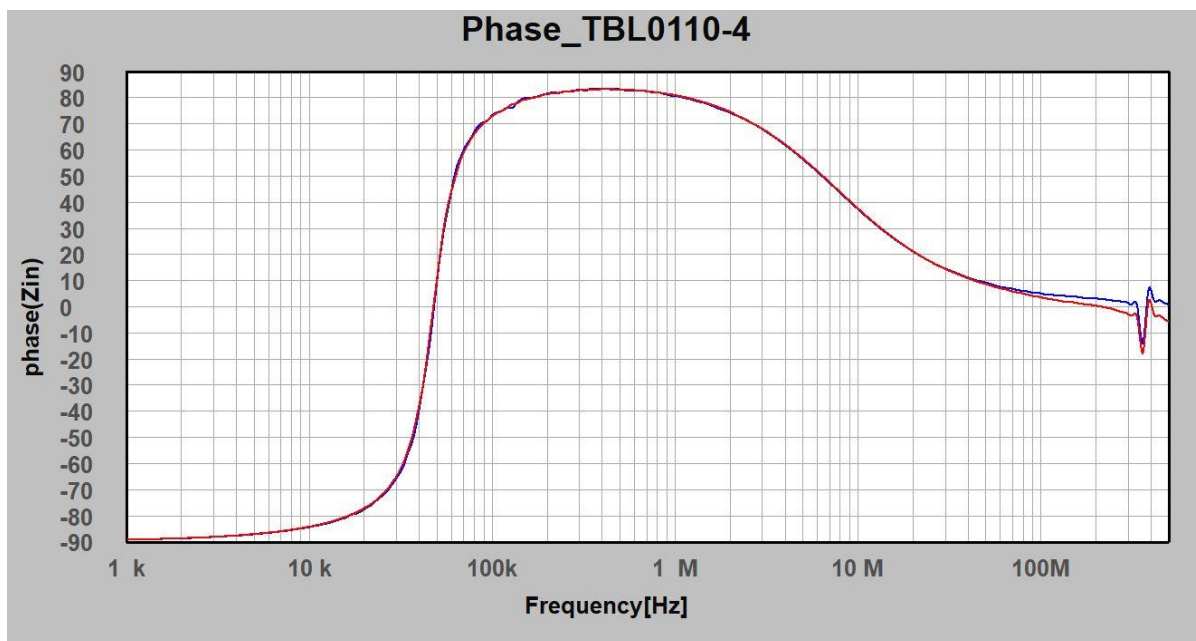

Input phase: 1 kHz – 500 MHz; source terminals open, typical data

# 1μH Line Impedance Stabilisation Network

## 5 Isolation

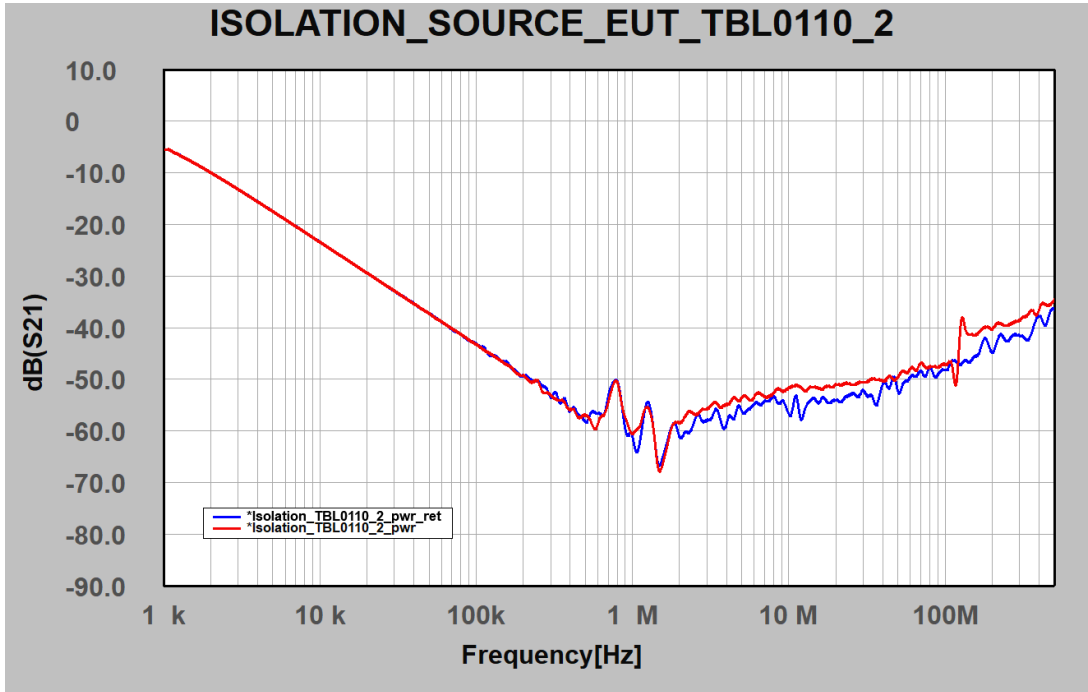

Isolation from SOURCE terminals to EUT terminals: 1 kHz – 500 MHz, typical data

## 6 Principle Schematics

In order to reproduce the system power bus impedance and to standardize the measurement conditions used in different test sites, emissions and susceptibility measurements on primary power lines shall be performed on inserting a Line Stabilization Network (LISN) between the EGSE power supply and the unit under test. The LISN schematic and the relevant impedance versus frequency are chosen in accordance with the bus impedance mask. The design of the LISN is usually provided by the spacecraft contractor. In case it is not available in time the LISN schematic and the relevant impedance versus frequency given below shall be used. Prior to test, the network impedance shall be measured in the relevant frequency range and attached to the test report.

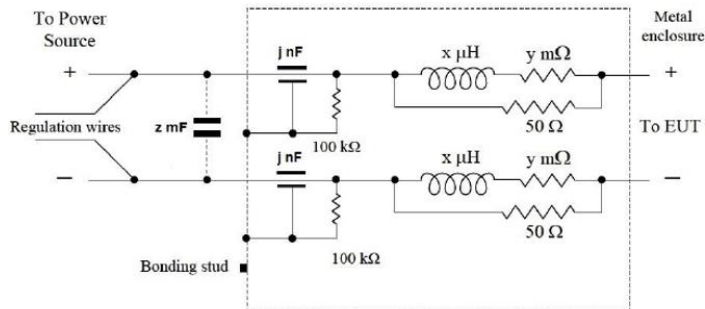

Figure 5-2: LISN schematic

$$X = 1 \mu\text{H} \quad Y = 100 \text{ m}\Omega \quad j = 11 \mu\text{F}$$

# 1 $\mu$ H Line Impedance Stabilisation Network

## 7 Measurement of conducted emissions

ECSSEST2007C specifies differential mode conducted emission measurements on power leads in the frequency range of 30 Hz to 100 kHz.

Furthermore, ECSSEST2007C specifies common mode and differential mode conducted emission measurements on power and signal leads in the frequency range of 100 kHz to 100 MHz.

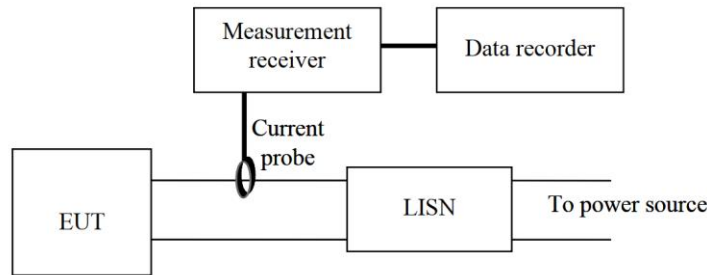

*Conducted emission, differential mode, measurement setup*

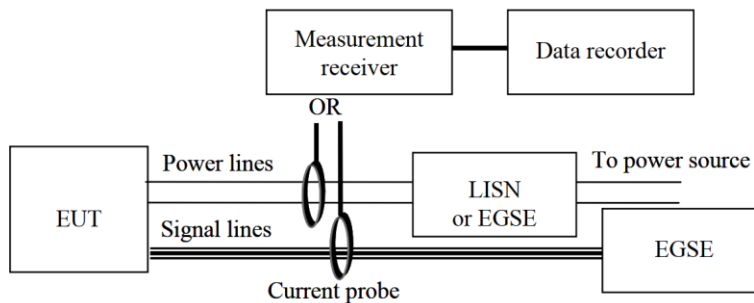

*Conducted emission, common mode, measurement setup*

*\*) EGSE: electrical ground support equipment*

Tekbox also provides suitable RF current monitoring probes, such as the TBCP2-30K400.

LISN are also required in other ECSSEST2007C measuring setups:

Radiated emission – electric field; inrush current; conducted susceptibility – signal injection; conducted susceptibility – bulk cable injection; conducted susceptibility – transients; conducted susceptibility – spike series / parallel injection; radiated susceptibility – magnetic field; radiated susceptibility – electric field;

## 8 References

ECSS-E-ST-20-07C Rev. 1

# 1µH Line Impedance Stabilisation Network

## 9 Ordering Information

Part Number	Description
TBL0110-2	1µH LISN, two path
TBCP2-30K400	Optional accessory: RF current monitoring probe for CE measurements

## 10 History

Version	Date	Author	Changes
V1.0	31.10.2023	Mayerhofer	Creation of the document
V1.1	31.10.2023	Mayerhofer	Chapter 7 added
V1.2	22.01.2024	Mayerhofer	Chapter 1, type error correction