

# Trans-conductance Amplifier / Current Injector

## 1 Introduction

The TBRFCI1 is a four quadrant RF trans-conductance amplifier / current injector / current source. The output has no dead zone and can source and sink current. It has a frequency range of 0 to 50 MHz, a maximum output voltage of  $\pm 45 V_{\text{peak}}$  and a maximum linear current of  $\pm 1 A_{\text{RMS}}$ .

### Applications:

- RF power amplifier to drive Helmholtz coils or loop antennas
- Current injector for DC power supply characterization
- Component testing
- Arbitrary Waveform Generator output amplifier
- General purpose dynamic load



# Trans-conductance Amplifier / Current Injector

## 2 Specification

### General specification

Frequency range:	DC – 50 MHz, useable up to 100 MHz
Transconductance:	0.1 A/V, 1 A/V
Operating temperature range:	-20°C to +40°C
Dimensions:	W 300 mm x H 150 mm x L 270 mm;
Weight:	6.6 kg

### Input specification

Input impedance:	0.1 V/A input: 50 $\Omega$	1 V/A input: 1 M $\Omega$
Maximum input level:	0.1 V/A input: $\pm 10$ V	1 V/A input: $\pm 1$ V
Input connectors:	BNC-female	
Input protection:	overdrive warning LED	

### Output specification

Output impedance:	high impedance current source output
Offset:	adjustable; $\pm 45$ V / $\pm 1$ A <sub>RMS</sub>
Output connector:	4 mm banana posts
Auxiliary output:	BNC-female; parallel to output connector
Maximum output voltage:	$\pm 45$ V <sub>peak</sub>
Maximum output current:	$\pm 1$ A DC, 1 A <sub>RMS</sub> AC
Maximum output power:	45 W DC; 31.5 W AC (frequency and load impedance dependent)
Voltage/current bandwidth:	load impedance dependent, see chapter 3.3
Rise time:	load and amplitude dependent; 6 ns to 25 ns; see chapter 3.4

### Current monitor output specification

Transimpedance:	1 V/A; typ. accuracy $\pm 10\%$ and linear phase up to 30 MHz
Output impedance:	50 Ohm
Output connector:	BNC – female

### Supply specification

Operating Voltage:	100 V – 120 V / 220 V – 240 V, 50 Hz / 60 Hz; switchable
Indicator LED:	Power ON
Current consumption:	750 mA
Connector:	EN 60320, C14

## Trans-conductance Amplifier / Current Injector

### 3 Operation

#### 3.1 User Interface

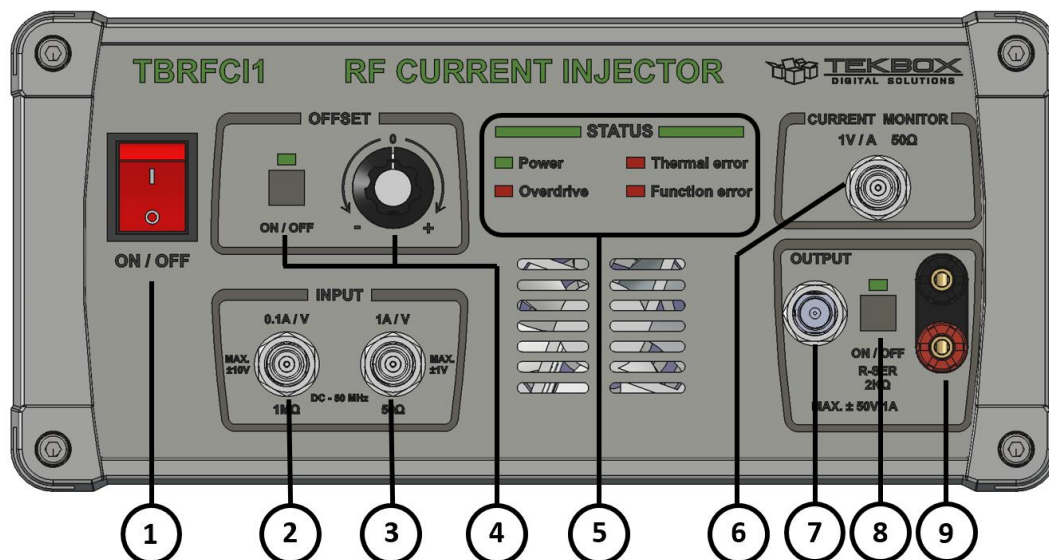

- 1) Mains Power Switch
- 2) Signal Input; BNC female; 1 M $\Omega$  input impedance; trans-conductance: 0.1A/V
- 3) Signal Input; BNC female; 50  $\Omega$  input impedance; trans-conductance: 1A/V
- 4) DC-Offset; max.  $\pm 45 V_{PEAK} / \pm 1A_{RMS}$  ; switch to turn offset ON/OFF; set to OFF after power up
- 5) Status LEDs
  - Power: indicates all internal supply voltages within correct range
  - Thermal Error: indicates over-temperature of the output stage
  - Overdrive: indicates overload status of the driver stage ( >500mA driver current; may happen at high frequencies / high output voltage, as current flows back into the driver stage via C<sub>DRAIN-GATE</sub> )
  - Function Error:
    - 1 Pulse – I2C error
    - 2 Pulses -  $\pm 15V$  supply, voltage out of range
    - 3 Pulses -  $\pm 50V$  supply, voltage out of range
    - 4 Pulses -  $\pm 50V$  supply, over-current
    - 5 Pulses - over-temperature error
    - 6 Pulses -  $\pm 15V$  supply, over-current
    - 7 Pulses – permanent overdrive error

Reduce the current or frequency and press the output button for 5 seconds to reset the amplifier.
- 6) Current monitor output; BNC-female; 50 Ohm output impedance;  $\pm 10\%$  accuracy up to 30 MHz; 2.5 ns delay; linear phase up to 30 MHz
- 7) Load output port; BNC; connect load or use it for monitoring of the output voltage (use a 10:1 high impedance probe, when monitoring the output voltage)
- 8) Output switch; first connect the load after powering on the device, then press the button to enable the output. With the output disabled, a 1.1K $\Omega$  resistor is switched in series to the output in order to protect the load from potential voltage or current transients. The switch will be OFF after resetting a function error. Don't forget to turn it on again to resume operation.
- 9) Load output port; 4mm banana posts; note that the internal wiring adds a series inductance of approximately 100 nH to the output port

# Trans-conductance Amplifier / Current Injector

## 3.2 Block diagram

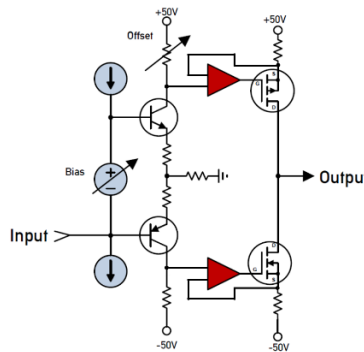

Figure 1- simplified block diagram



Figure 2- output switch

The amplifier is a DC coupled four quadrant current source designed for stable operation across a wide range of load impedances and it is optimized for a wide frequency range.

The output current is proportional to the input voltage whereas the output voltage is given by the output current multiplied by the frequency dependent load impedance:

$$I_{out}(t) = Y_{trans} V_{in}(t) \quad \text{with} \quad Y_{trans} = 1 \left[ \frac{A}{V} \right]$$

$$\text{and} \quad V_{out} = I_{out} Z(\omega) = Y_{trans} V_{in} Z(\omega)$$

A current monitor circuit measures the voltage drop across the current sense resistors at the source of the output FETs.

## 3.3 Output Power bandwidth

The maximum DC output power is 45 watts.

The power bandwidth for AC/RF input signals is primarily determined by the load impedance. Because the amplifier operates with a wide range of load impedances, it cannot be defined generally. 90 V<sub>pp</sub> is equivalent to 31.5 V<sub>RMS</sub>. With a maximum output current of 1 A<sub>RMS</sub>, the RF output power is 31.5 W. Maximum power can be achieved with a load impedance of 31.5 Ω. With higher load impedances, the output voltage goes into saturation with currents below 1 A<sub>RMS</sub> and with lower load impedances, the output voltage cannot reach its maximum amplitude.

Furthermore, power is limited by monitoring and controlling the supply current of the output driver stage. The FETs have a combined Gate capacitance of 400 pF. With increasing frequency and output power, the Gate current increases and the driver stage may become overloaded. When the supply current of the driver exceeds its maximum rating of 500 mA, the Overdrive LED goes on and the output is disabled. Reduce the amplitude and / or the frequency of the input signal and press the output switch for 5 seconds to reset the amplifier.

# Trans-conductance Amplifier / Current Injector

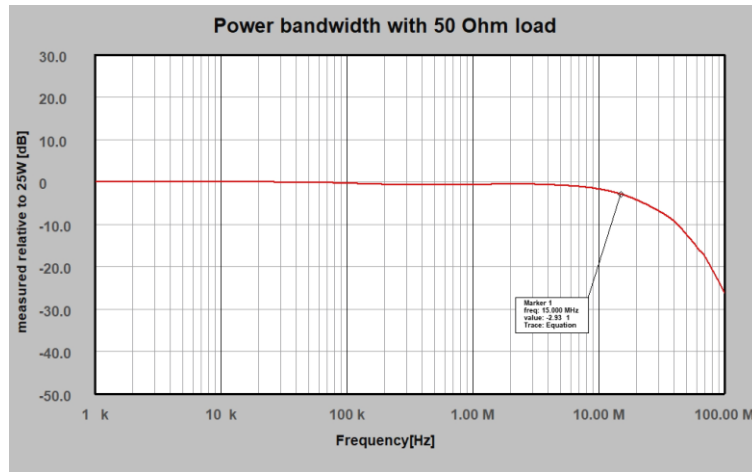

Figure 2 - Example: 3 dB Power bandwidth with 50 Ohm load: 17 MHz

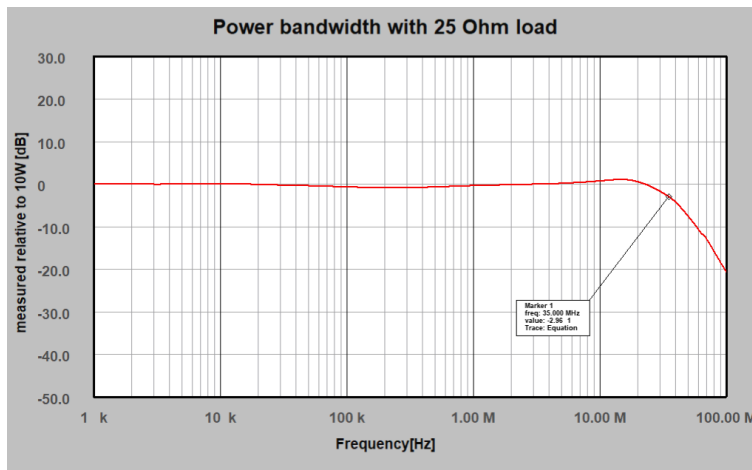

Figure 3 - Example: 3 dB Power bandwidth with 25 Ohm load: 35 MHz

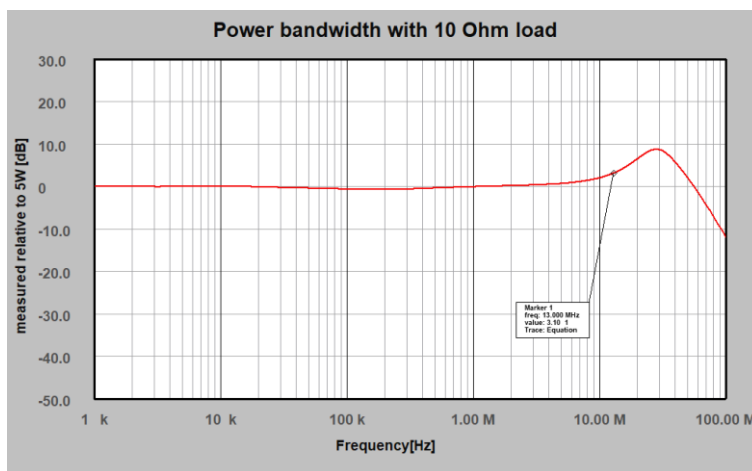

Figure 4 - Example: 3 dB Power bandwidth with 10 Ohm load: 13 MHz

# Trans-conductance Amplifier / Current Injector

## 3.4 Rise time

The minimum rise time depends on the load impedance and output current amplitude. It is in the range of 6 ns to 25 ns.

**Example: 50 Ohm Load; 1 MHz square wave; yellow trace: voltage; magenta trace: current**

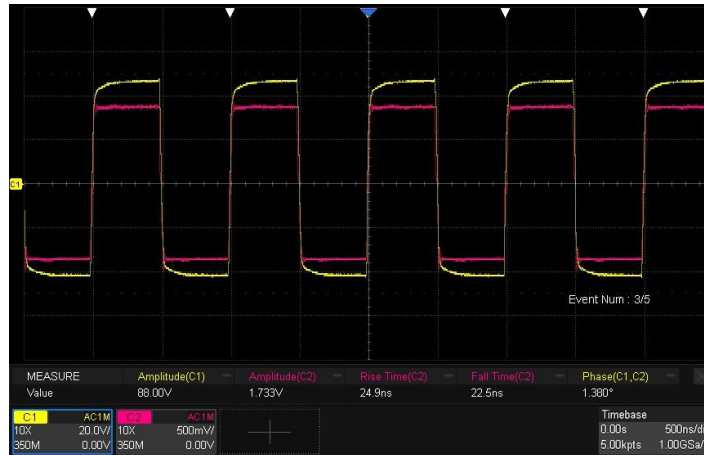

Figure 5: Output voltage 88 Vpp; Output current 1.73 App; rise time: 25 ns; fall time 22.5 ns

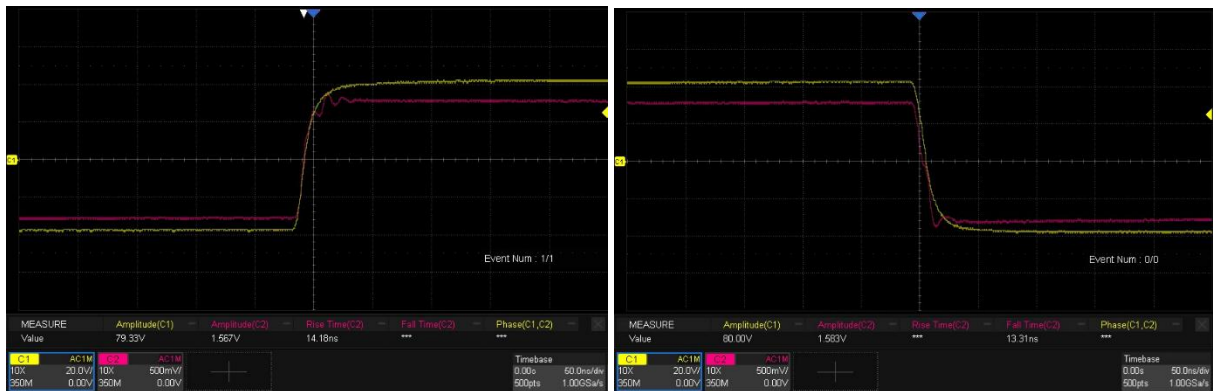

Figure 6: Output voltage 80 Vpp; Output current 1.6 App; rise time: 14 ns; fall time 7.4 ns

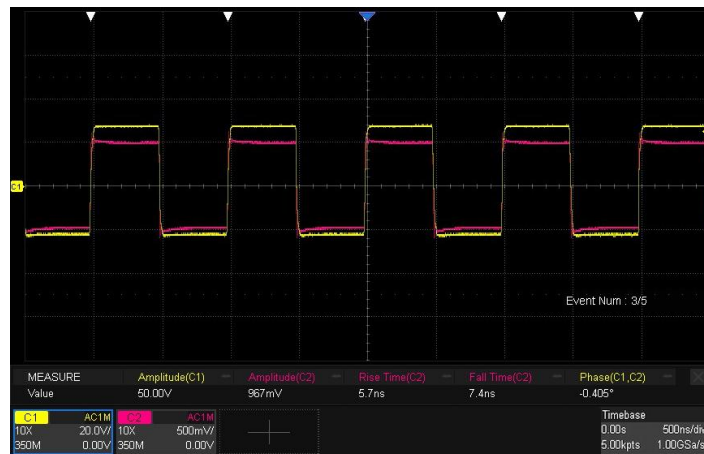

Figure 7: Output voltage 50 Vpp; Output current 0.97 App; rise time: 5.7 ns; fall time 7.4 ns

# Trans-conductance Amplifier / Current Injector

Example: 25 Ohm Load; 1 MHz square wave; yellow trace: voltage; magenta trace: current

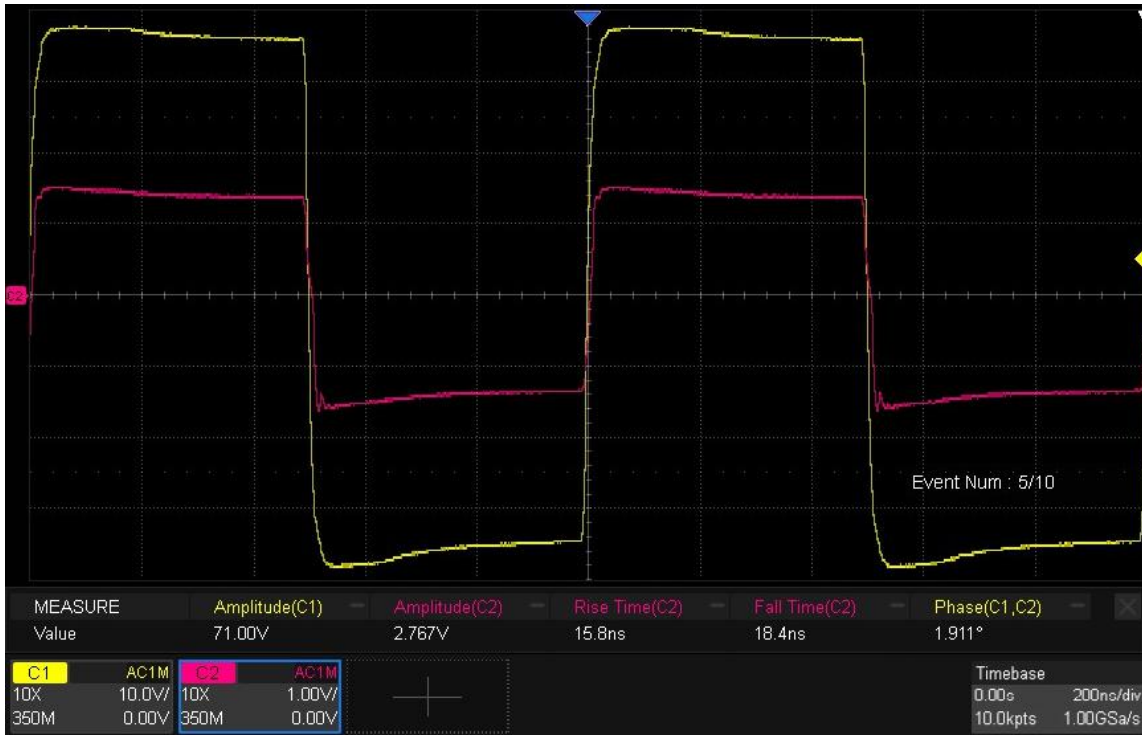

Figure 8: Output voltage 71 Vpp; Output current 2.8 App; rise time: 16 ns; fall time 18 ns

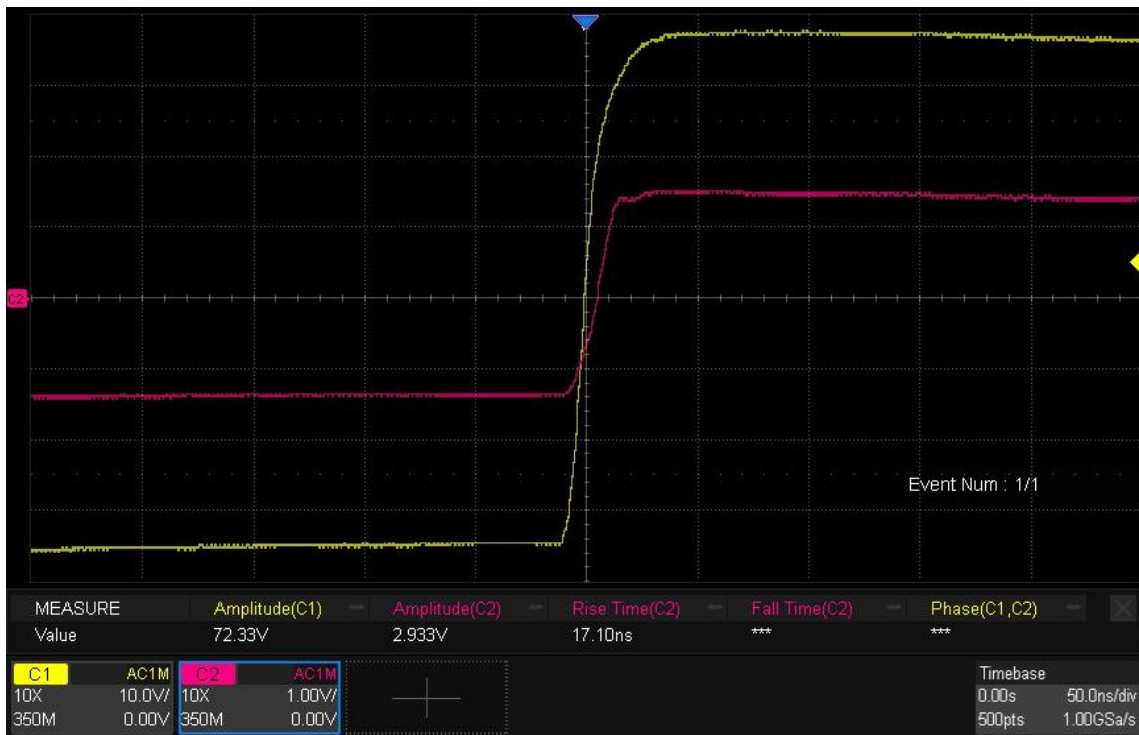

Figure 9: Output voltage 72.3 Vpp; Output current 2.93 App; rise time: 17 ns

## Trans-conductance Amplifier / Current Injector

### 3.5 Current Monitor

The current monitor measures the current through the source resistors of the output power FETs. The current monitor output voltage trans-impedance is 1 V/A. It has an accuracy of  $\pm 10\%$  and linear phase up to 30 MHz. Above, the accuracy of the implemented current source and current monitor is degraded by the parasitic capacitances of the output FETs.

For applications, where accuracy and phase is important, measure current with a current monitoring probe. Steep slopes may cause overshoot / ringing of the current monitor output voltage, which is not present in the actual current.

Connect a 50 Ohm BNC feed-through to the current monitoring output, if using a high impedance oscilloscope probe. Set the oscilloscope input to 50  $\Omega$ , if connecting with a coaxial cable.

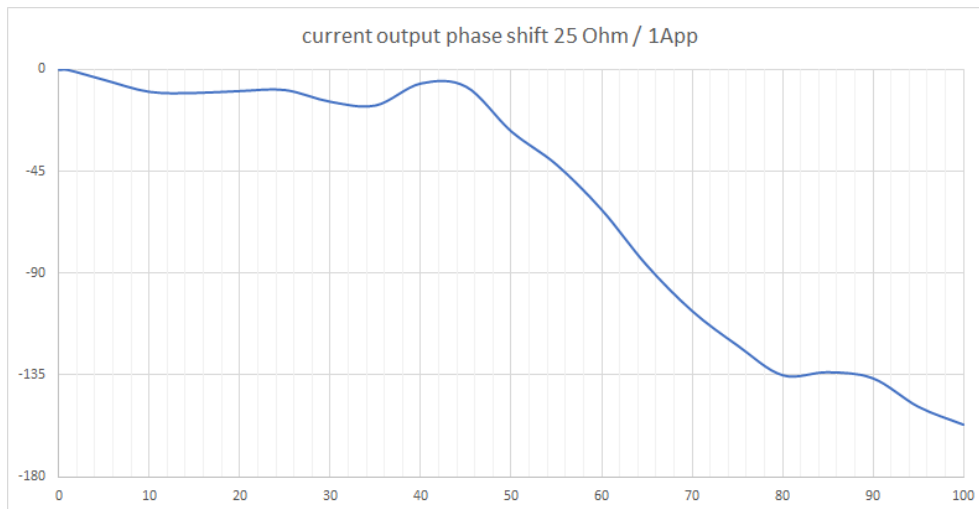

Figure 10: phase of current monitoring output voltage vs. load current; 25  $\Omega$  load; output current 1App

## 4 Applications

- **Driving loop antennas and Helmholtz coils**

Driving loop antennas with constant current vs. frequency results in constant magnetic field strength vs. frequency. RE101 and RS101 antennas can be conveniently calibrated with the TBRFC11.

- **Component characterisation**

You can measure impedance using the TBRFC11 in combination with an oscilloscope with Bode Plot capability.

The Bode Plot feature measures loop gain and phase.

$$Gain = \frac{V_{out}}{V_{in}}$$

Substitute  $V_{out}$  with the Voltage  $V_{comp}$  measured across a component or network and substitute  $V_{in}$  with the current  $I_{comp}$  through the component or network and you obtain the impedance:

$$|Z_{comp}| = \frac{V_{comp}}{I_{comp}}$$

## Trans-conductance Amplifier / Current Injector

$I_{comp}$  is represented by a proportional voltage, such as the output voltage of a current probe or current monitor. In case of the TBRFCI1, the current monitor output has a transimpedance of 1 V/A, so  $V_{in}$  can be substituted by  $V_{monitor}$  without any further scaling:

$$|Z_{comp}| = \frac{V_{comp}}{V_{monitor}}$$

Example: measurement of a 25 Ω resistor to validate the setup

Setup:

Siglent SDS2354X Plus oscilloscope; Ch1 connected to the current monitoring output of the TBRFCI1; note that the BNC connector of the current monitor is terminated with a 50 Ohm feedthrough termination; Ch2 is connected to the BNC connector parallel to the output terminals of the TBRFCI1. The 25 Ω resistor is clamped to the output banana posts of the TBRFCI1.

Bode settings:

Dut Input	Ch2	Current monitoring output via BNC feedthrough termination	
Dut Output	Ch1	TBRFCI1 BNC output	
sweep type	simple	Freq. Mode	linear
Center	2.5 MHz	Span	2.5 MHz
Points	50		
Amplitude	0.1V	Offset	0 V
Amplitude unit	Vpp		
Load	50 Ohm		

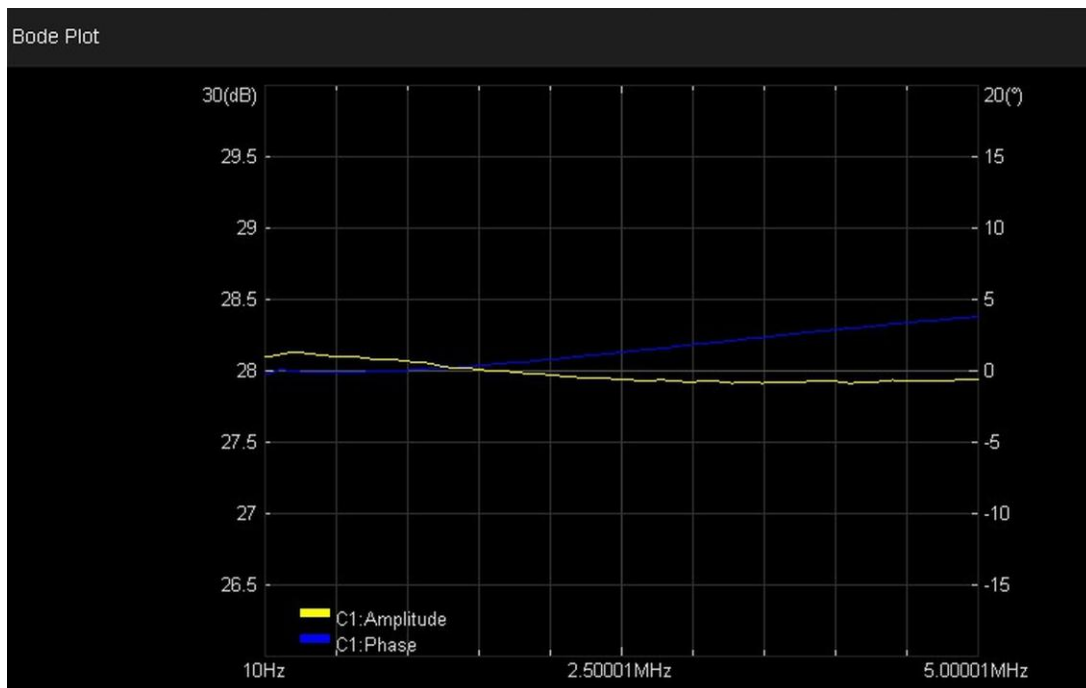

Figure 11: resulting Bode plot

Export the Bode data as CSV, convert it into an Excel file and delogarithmize the gain column:

$$|Z_{comp}| = 10^{\frac{Ch1[dB]}{20}}$$

# Trans-conductance Amplifier / Current Injector

Create a diagram:

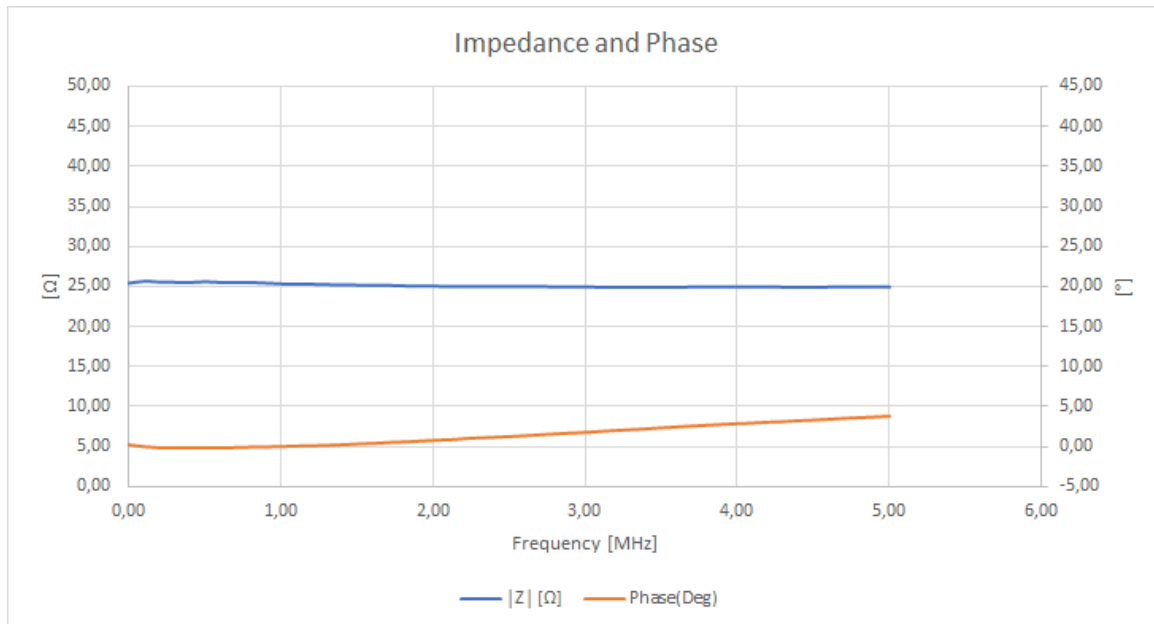

Figure 12: delogarithmized Bode plot of the 25 Ohm resistor

Example: measurement of a LC circuit, 8.2μH // 470 pF

Use the same setup as in the example before and replace the resistor with the 8.2μH // 470 pF circuit.

Anticipating the voltage increase at resonance, we set the Bode excitation current to 0.01 V to avoid driving the current source into voltage saturation.

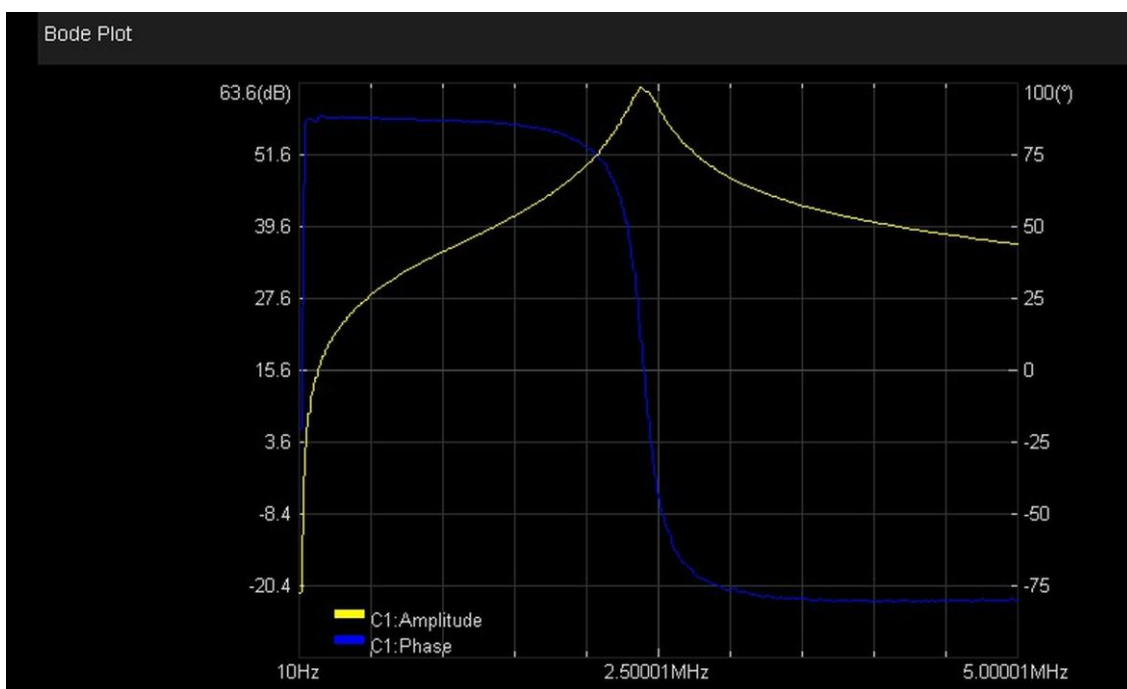

Figure 13: resulting Bode plot

## Trans-conductance Amplifier / Current Injector

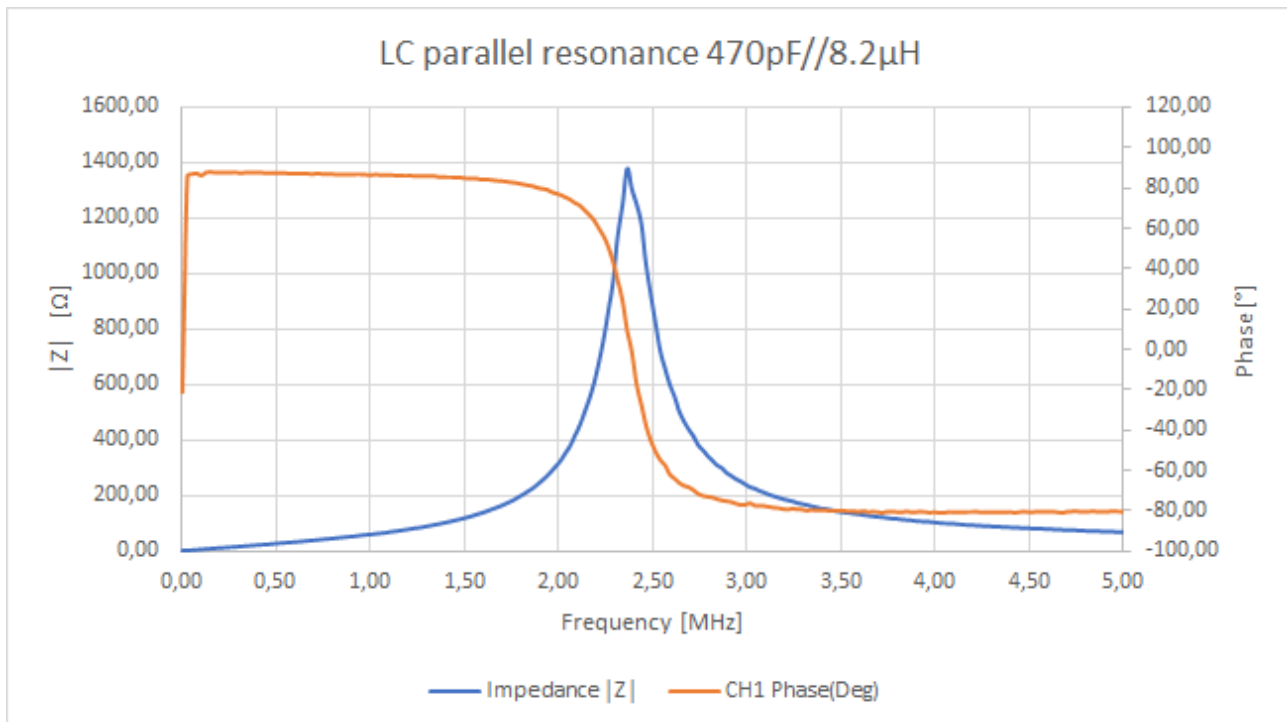

Figure 14: delogarithmized Bode plot of the LC parallel resonance circuit

- **DC Power supply characterisation**

The TBRFCI1 can be used to characterize power supplies with respect to fast load transients. Furthermore, it can be used to carry out impedance measurements.

It is good practice to keep the wiring between amplifier output and device under test as short as possible. It is also recommended to twist the connecting wires in order to keep the wiring inductance as low as possible.

Most power supplies can only source, but not sink current. Press the offset button and use the offset potentiometer of the amplifier to establish a suitable bias point.

Example: load transients of a standard lab power supply, set to +12V output voltage

- Connect the power supply to the output of the TBRFCI1. Keep the connecting wires as short as possible and twist it.
- Turn on the output of the TBRFCI1.
- Push the Offset button and set a base current. To test 1A load transients, turn the offset potentiometer counter-clockwise, until the current monitor shows a DC current of – 500 mA or the display at the power supply shows a current of 500 mA.
- Connect the arbitrary waveform generator to the 1A/V input. Set it to square wave, 500 Hz, 50 Ω output impedance and 1Vpp amplitude.
- Measure the voltage at the output terminals of the power supply and the current at the current monitoring output using an oscilloscope.

## Trans-conductance Amplifier / Current Injector



Figure 15: load transient measurement

DUT: Korad KA6005P; connected to TBRFC11 via 1m cables, twisted;

Magenta trace: current monitoring output, DC coupled, 500mV/DIV, 1A square wave load current, 500 Hz;  
rise time: 13 ns, fall time: 10 ns

Yellow trace: voltage at power supply terminals; AC coupled, 1V/DIV

Use Bode analysis to measure the output impedance of the power supply. Keep the offset as for the transient measurement, but connect the power supply as close as possible to the TBRFC11 in order to reduce the influence of the inductance of the connecting wires for this measurement.

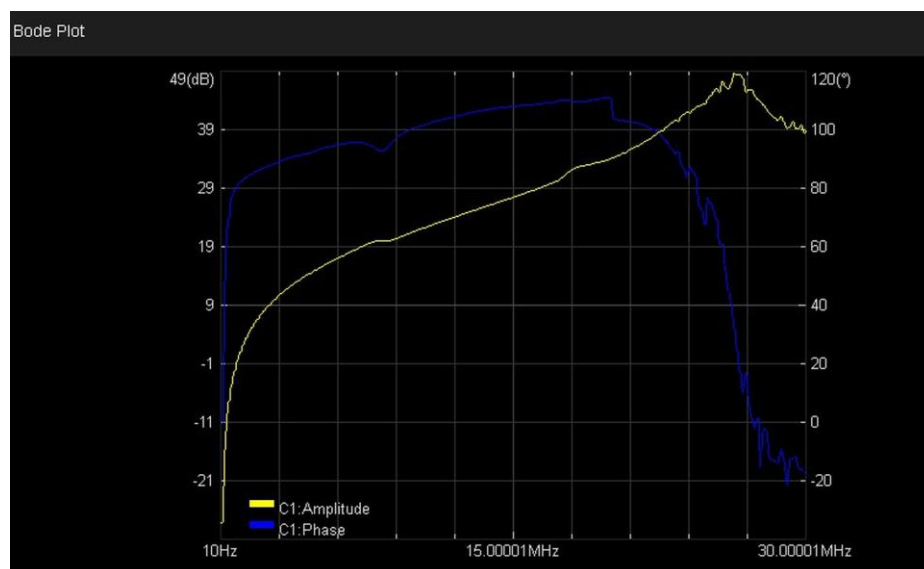

Figure 16: Bode plot of the power supply impedance

# Trans-conductance Amplifier / Current Injector

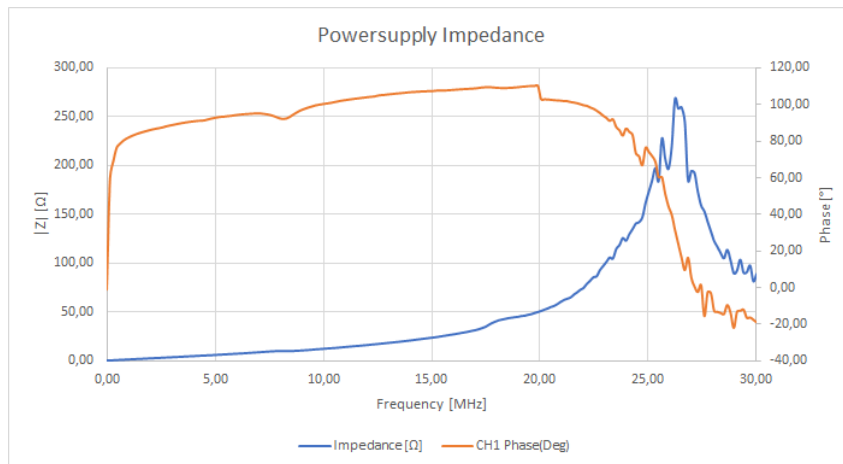

Figure 17: delogarithmized Bode plot of the power supply impedance

- **Output amplifier for Arbitrary Waveform Generators**

Standard Arbitrary Waveform Generators have limitations with respect to driving low impedance loads or creating high output voltages. The TBRFC11 can expand the capabilities for both low impedance and high voltage within its envelope of maximum voltage and current rating.

Example: driving low impedance loads

0.5 Ohm wire-wound power resistor connected to the output with 0.5 meter twisted cable. Frequency: 5 MHz; Magenta trace: current; yellow trace: voltage measured across the resistor terminals. Note that the inductance of the resistor causes the voltage across the resistor terminals to increase with frequency. Twist the connecting wires to reduce series inductance in the setup.



Figure 18: Output loaded with 0.5 Ohm wire wound resistor, 5 MHz; 23 Vpp, 1.8 App

## Trans-conductance Amplifier / Current Injector

### 5 Ordering Information

Part Number	Description
TBRFCI1 – 110V	Transconductance amplifier, device set to 100V – 120V supply voltage
TBRFCI1 – 230V	Transconductance amplifier, device set to 200V – 240V supply voltage

### 6 History

Version	Date	Author	Changes
V1.0	5.2.2026	Mayerhofer	Creation of the document

# Trans-conductance Amplifier / Current Injector

**TekBox Digital Solutions Vietnam Pte. Ltd.**

[www.tekbox.com](http://www.tekbox.com)

Factory 4, F4, Lot I-3B-1, Saigon Hi-Tech Park, Tan Phu Ward, District 9, Ho Chi Minh City, Vietnam